

## Operating instructions (original)

### Air shower green dec

**Air generator green dec type 825  
Variable air shower enclosure**



	deconta GmbH Im Geer 20 46419 Isselburg	Telephone: 02874/9156-0	Language: EN
		Fax: 02874/9156-11	Version: 2
		E-mail: info@deconta.com	Date of issue: 25.06.2025
		Web: www.deconta.com	

<b>1</b>	<b>Product and manufacturer .....</b>	<b>5</b>
1.1	Product.....	5
1.2	Manufacturer .....	5
1.3	Change index .....	5
<b>2</b>	<b>About these operating instructions.....</b>	<b>6</b>
2.1	Purpose.....	6
2.2	Availability .....	6
2.3	Warnings.....	7
2.3.1	Signal words and signal colours.....	7
2.3.2	Structure .....	7
2.4	Symbols .....	8
2.4.1	Warning signs.....	8
2.4.2	Instruction sign .....	8
<b>3</b>	<b>Description of the machine.....</b>	<b>9</b>
3.1	General description .....	9
3.2	Scope of delivery.....	9
3.3	Return delivery after termination of a rental .....	9
3.4	Operating modes.....	10
3.4.1	Available operating modes.....	10
3.5	Interfaces .....	10
3.6	Type plate .....	11
3.6.1	Execution.....	11
3.6.2	Position.....	11
<b>4</b>	<b>Technical data.....</b>	<b>12</b>
4.1	Dimensions .....	12
4.2	Mass .....	12
4.3	Energy supply .....	12
4.4	Hose connections.....	12
4.5	Filter system.....	12
4.6	Leistungsdaten.....	13
	Ambient conditions .....	13
<b>5</b>	<b>Security .....</b>	<b>14</b>
5.1	Intended use .....	14
5.2	Misapplication .....	15
5.3	Tasks and qualifications of staff.....	16
5.4	Notes on occupational health and safety.....	17
<b>6</b>	<b>Transport.....</b>	<b>18</b>
6.1	Loss of warranty claims .....	18
6.2	External transport.....	18
6.2.1	Transport space.....	18
6.2.2	Legislation .....	18
6.2.3	Qualification of staff .....	18

6.2.4	Warning of residual risks.....	18
6.2.5	Means of transport.....	19
6.3	Internal transport.....	19
6.3.1	Transport space.....	19
6.3.2	Legislation.....	19
6.3.3	Warning of residual risks.....	19
6.3.4	Means of transport.....	19
<b>7</b>	<b>Assembly.....</b>	<b>20</b>
7.1	Air shower cubicle.....	20
7.2	Air generator.....	23
7.3	Connect control line(s).....	25
7.3.1	Version with on/off control.....	25
7.3.2	Version with automatic shower control.....	25
7.3.3	Version with forced locking control and forced shower.....	26
<b>8</b>	<b>Put into operation.....</b>	<b>27</b>
8.1	Qualification of staff.....	27
8.2	Warning of residual risks.....	27
8.3	Number of persons.....	27
8.4	Tools required.....	27
8.5	Equipment required.....	27
8.6	Version with on/off control.....	28
8.7	Version with automatic shower control.....	29
8.8	Version with forced locking control and forced shower.....	30
<b>9</b>	<b>Maintenance.....</b>	<b>32</b>
9.1	Loss of warranty claims.....	32
9.2	Maintenance.....	32
9.3	Warning of residual risks.....	32
9.3.1	Personal protective equipment required.....	33
9.4	Information on changing the filter.....	33
9.5	Filter change.....	34
9.5.1	Changing the air shower enclosure filter.....	34
9.5.2	Change the air generator filter.....	35
9.6	Troubleshooting and fault rectification.....	37
9.6.1	Possible faults and instructions for rectifying faults.....	37
<b>10</b>	<b>Storage.....</b>	<b>38</b>
10.1	Ambient conditions.....	38
10.2	Prerequisites.....	38
<b>11</b>	<b>Waste disposal.....</b>	<b>39</b>
11.1	Qualification of staff.....	39
11.2	Legislation.....	39
11.3	Waste.....	39
<b>12</b>	<b>EC Declaration of Conformity.....</b>	<b>40</b>



## 1 Product and manufacturer

### 1.1 Product

The following product is described in these operating instructions:

Air shower green dec

### 1.2 Manufacturer

Name and address	deconta GmbH Im Geer 20 46419 Isselburg
	
Telephone	02874/9156-0
Fax	02874/9156-11
e-mail	info@deconta.com
Internet	www.deconta.com

### 1.3 Change index

date	Version	Amendment	Responsible
14.04.2025	2	Complete revision	Thomas Boland

## 2 About these operating instructions

To ensure proper and safe use of the machine, follow the descriptions and recommended actions in these operating instructions.

Keep these operating instructions for future reference until the machine has been disposed of.

### 2.1 Purpose

These operating instructions contain information on the safe, trouble-free and economical use of the machine.

This information is intended for persons who perform tasks with or in connection with the machine.

The following table provides an overview of people and tasks.

Person	Task
Operator	<< Machine-specific >>
Occupational safety specialist	<ul style="list-style-type: none"> <li>• Carry out a risk assessment</li> <li>• Create operating instructions</li> <li>• Instruct persons</li> </ul>
Maintenance engineer	Maintenance of the mechanics
Qualified electrician (EFK)	Installation and maintenance of electrical equipment
Freight forwarder	External transport of the machine
Conveyor	Internal transport of the machine
Disposer	Dispose of the machine in a legally compliant, proper and professional manner

### 2.2 Availability

The operator shall make these operating instructions or extracts thereof available to persons who carry out tasks with or in connection with the machine.

The operator must keep these operating instructions or extracts thereof within easy reach in the immediate vicinity of the machine.

If the machine is handed over to another person, the operator passes these operating instructions on to this person.





## 2.3 Warnings

These operating instructions contain warnings of residual dangers.

The categorisation of the warnings is based on the severity of the damage that can occur if the warnings are ignored and the recommended actions are not followed.

### 2.3.1 Signal words and signal colours

Warnings are introduced with one of the following signal words and marked with a corresponding signal colour.

Signal word	Meaning	Signal colour
DANGER	Consequence of non-compliance: Death or serious injury.	
WARNING	Consequence of non-compliance: Death or very serious injuries possible.	
CAUTION	Consequence of non-compliance: Serious or minor injuries possible.	
NOTE	Consequence of non-compliance: Material damage or environmental damage possible.	
SAFE HANDLING	Implement the following instructions.	-

### 2.3.2 Structure

Warnings are structured according to the SAFE method:

<b>S</b>	Signal word (DANGER; WARNING, CAUTION or NOTICE)
<b>A</b>	Type and source of danger Description of the hazard and the cause of the hazard
<b>F</b>	Consequence Description of the possible consequences of the hazard for humans, animals and the environment
<b>E</b>	Escape Recommendations on how hazards can be avoided



## 2.4 Symbols

The following symbols are used in these operating instructions.

### 2.4.1 Warning signs

The warning sign is a safety sign that warns of a risk or danger.



The following table provides an overview of the warning signs used and their meaning.

Symbol	Meaning	Symbol	Meaning
	Warning of electrical voltage		General warning sign

### 2.4.2 Instruction sign

The instruction sign is a safety sign that prescribes certain behaviour.

The following table provides an overview of the instruction symbols used and their meaning.

Symbol	Meaning	Symbol	Meaning
	Wear safety shoes		Use protective clothing

### **3 Description of the machine**

This section contains information on understanding the machine.

#### **3.1 General description**

The air shower essentially consists of two main components, the air shower cabin and the air generator.

In the air shower cabin, a person's entire body is blown off using a large volume flow to remove dust, fibres and the like. It is important that the person to be cleaned moves in the air flow so that all parts of the body are blown off.

The air generator extracts the air in the floor area. This air is filtered in 4 stages (EU3 filter in the air shower cabin, EU3, EU4 and HEPA filter in the air generator).

The purified air is blown back into the air shower cubicle via 4 hose connections in 2 walls.

#### **3.2 Scope of delivery**

The scope of delivery of the machine includes the following items:

- Air generator green dec
- Air shower cubicle
- These operating instructions
- Suction adapter
- Sealing plugs

#### **3.3 Return delivery after termination of a rental**

For the protection of our customers and in accordance with the dangerous goods transport regulations, we must insist on the following return delivery conditions:

- As listed above
- Thoroughly cleaned (ready for use)
- Free from any adhesive residue
- Without residual fibre bonding
- Without filter
- Without damage

### **3.4 Operating modes**

#### **3.4.1 Available operating modes**

##### **Type of utilisation**

The machine is intended exclusively for use in the following types of utilisation.

Use for other types of utilisation is not in accordance with the intended purpose.

##### **User groups**

- Commercial users

##### **Utilisation environment**

- on roofed areas
- in rooms closed on all sides

##### **Operating modes**

Operating modes for use:

- Manual operation
- Automatic mode

### **3.5 Interfaces**

This section contains information about interfaces.

The following interfaces are available on the machine:

- Machine > Man: Main switch, operating buttons and key switch
- Machine > Energy supply
- Electrical power supply: CEE surface-mounted appliance plug 400V 16A

**3.6 Type plate**

The rating plate contains information for identifying the machine.

**3.6.1 Execution**

Aluminium plate, riveted

**3.6.2 Position**

Near the control panel on the outlet side.

## 4 Technical data

This section contains technical data describing the machine.

### 4.1 Dimensions

Air generator (L x W x H)	1460 x 705 x 960 mm
ECO-Line model 1000 air shower enclosure (L x W x H)	1090 x 1250 x 2000 mm
Classic air shower enclosure model 1000 (L x W x H)	1124 x 1280 x 2245 mm

### 4.2 Mass

Air generator weight	approx. 130 kg
Weight air shower enclosure ECO-Line model 1000	approx. 90 kg
Weight air shower enclosure Classic model 1000	approx. 145 kg

### 4.3 Energy supply

Power connection	400 V, 16 A
Power consumption	6,5 A
Performance	2.2 KW

### 4.4 Hose connections

Air generator pressure side	4x NW 75
Air generator suction side	1x NW 150
Air shower enclosure pressure side	4x NW 75
Air shower enclosure suction side	1x NW 150

### 4.5 Filter system

Air generator	Pre-filter EU3 / 610 x 610 x 47 mm
	Intermediate filter EU4 / 610 x 610 x 47 mm
	HEPA filter H13 or H14 / 610 x 610 x 292 mm
Air shower cubicle	Pre-filter EU3 / 305 x 305 x 47 mm

**4.6 Leistungsdaten**

*All data on air performance and volumetric flows taking into account a measurement tolerance of  $\pm 15\%$  referred to the measuring range end value, determined in a multi-point measurement procedure with a calibrated impeller anemometer.*

Air output with deconta filters and hoses, nozzles completely open	max. 1200 m <sup>3</sup> /h
--	-----------------------------

*Subject to technical changes*

**Ambient conditions**

Ambient temperature	0 °C to +45 °C
Relative humidity	70 % non-condensing

## 5 Security

This section contains information on the protection of people and the environment.

### 5.1 Intended use

The machine is intended exclusively for the following use:

#### **Intended use**

In the air shower cabin, a person's entire body is blown off by an air generator using a large volume flow, thus removing dust, fibres or similar. It is important that the person to be cleaned moves in the air flow so that all parts of the body are blown off.

The appliance is not suitable for filtering flammable gases or dusts.

The user must comply with the operating parameters specified in the operating instructions. The appliance may only be used in accordance with its intended purpose. Any other use beyond this is not in accordance with the intended use. The user is liable for any resulting damage or injuries of any kind.

#### **Authorised persons**

The following persons are authorised to handle the product:

- Specialised personnel
  - Task: Maintenance and servicing
  - Qualification: trained specialist personnel (fitters, industrial mechanics, electricians) with knowledge and experience in handling the machine
- Operating personnel
  - Task: Operation
  - Qualification: Training activity, information through operating instructions

Any other use is not in accordance with the intended use.

#### **Field of application**

The machine is intended for use in the following areas of application:

#### **Area of application**

- Refurbishments

## 5.2 Misapplication

Use of the machine for the following purposes is not permitted:

### **Reasonably foreseeable misuse**

- Any application other than that described in the operating instructions
- Any use of the machine other than that described under "Intended use" without the written consent of the manufacturer
- Operation outside the technical limits of use
- Unauthorised modifications or conversions and tampering
- Use, installation, operation, maintenance or repair in a manner other than described
- Work carried out by unqualified personnel
- Use of unsuitable or incompatible materials, operating or auxiliary materials or accessories
- Non-compliance with safety and operating instructions, occupational safety and accident prevention regulations or relevant statutory regulations
- Failure to promptly rectify faults that could jeopardise safety
- Use of non-original replacement parts or accessories that are not equivalent in quality and function
- Operating the machine in a technically unsatisfactory condition, not being aware of safety and hazards and not observing all instructions in the documentation

**5.3 Tasks and qualifications of staff**

<b>Person</b>	<b>Task</b>	<b>Required qualification</b>
Operator	<< Machine-specific >>	Instruction, training
Occupational safety specialist	<ul style="list-style-type: none"> <li>• Carry out a risk assessment</li> <li>• Create operating instructions</li> <li>• Instruct persons</li> </ul>	Completed training as an occupational safety specialist with recent experience with machines
Qualified electrician	Installation and maintenance of electrical equipment	A person with suitable training, appropriate education, timely experience and knowledge of the relevant regulations that enables them to recognise risks and avoid hazards that may arise from electricity.
Freight forwarder	External transport of the machine	A person with suitable training, appropriate education, up-to-date experience and knowledge of the relevant regulations, who is able to transport machines safely off-site.
Conveyor	Internal transport of the machine	A person with suitable training, appropriate education, up-to-date experience and knowledge of the relevant regulations, who is able to transport machines safely within the company.
Disposer	Dispose of the machine	Qualified waste disposal company for legally compliant, proper and professional disposal of the machine

#### **5.4 Notes on occupational health and safety**

The operator of the machine is responsible for implementing the obligations arising from occupational health and safety. The health and safety regulations of the country in which the machine is used apply.

The obligations include the following points:

- make these operating instructions or extracts available to persons who carry out tasks with or in connection with the machine
- Provide the applicable documents to these persons
- Instruction of persons with regard to the intended use and misuse
- Instruction of persons with regard to protective devices and supplementary protective devices
- Instruction of persons with regard to residual risks

This list is not exhaustive and does not claim to be complete.

## 6 Transport

This section contains information on external and internal transport of the machine.

Transport is the movement of the machine by manual or technical means.

### 6.1 Loss of warranty claims

The manufacturer's warranty is void in the following cases:

- In the event of modifications to the machine that have not been agreed with the manufacturer
- If the transport is not carried out properly

### 6.2 External transport

#### 6.2.1 Transport space

Off-site transport takes place in public areas. The machine is transported from one location to another.

#### 6.2.2 Legislation

The off-site transport of the machine is carried out in accordance with the legal regulations of the country in which the machine is transported off-site.

#### 6.2.3 Qualification of staff

Persons transporting the machine outside the company must fulfil the following requirements:

Person	Required qualification
Freight forwarder	Completed training in transport and experience in the external transport of machines
Logistician	Completed training and experience in the internal transport of machines

#### 6.2.4 Warning of residual risks



Risk of crushing: Wear safety shoes to protect limbs from being run over.

### 6.2.5 Means of transport

A means of transport that fulfils the following requirements is needed for safe external transport:

- The load capacity must be dimensioned so that the mass of the machine can be safely supported.
- The size of the transport surface must be dimensioned so that the machine can be parked safely on the transport surface without falling.



Machine may fall down due to unintentional change of position when loading and unloading onto/from a means of transport.

## 6.3 Internal transport

### 6.3.1 Transport space

During internal transport, the machine is transported from one installation location to another on the company premises.

### 6.3.2 Legislation

The internal transport of the machine is carried out in accordance with the legal regulations of the country in which the machine is transported outside the company.

### 6.3.3 Warning of residual risks



Risk of crushing: Wear safety shoes to protect limbs from being run over.

### 6.3.4 Means of transport

A means of transport that fulfils the following requirements is needed for safe internal transport:

- The load capacity must be dimensioned so that the mass of the machine can be safely supported.
- The size of the transport surface must be dimensioned so that the machine can be parked safely on the transport surface without falling.



Machine may fall down due to unintentional change of position when loading and unloading onto/from a means of transport.

## 7 **Assembly**

This section contains information on setting up the air shower enclosure and connecting the air generator.

### 7.1 **Air shower cubicle**

The pictures show the installation using the ECO-Line model 1000 air shower enclosure as an example.

- Set up the floor element, making sure that the surface is level and clean.

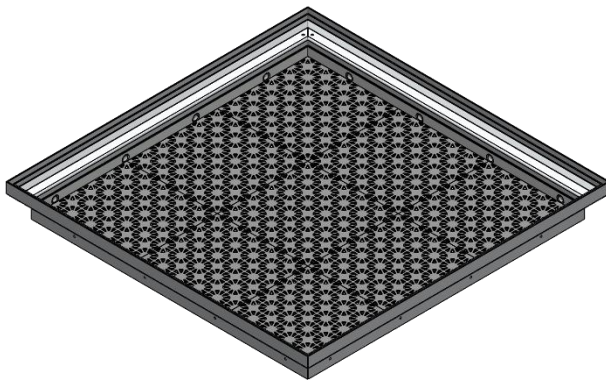

- Insert the corner profile at the corner of the floor element into the mounting brackets and tighten the quick-release fastener attached to the end of the corner profile to the floor element.

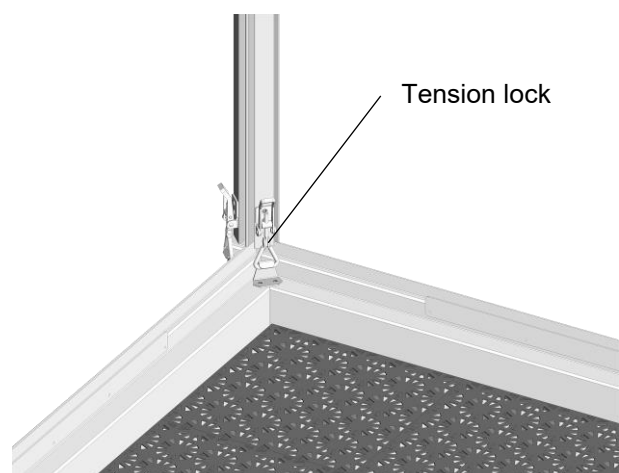
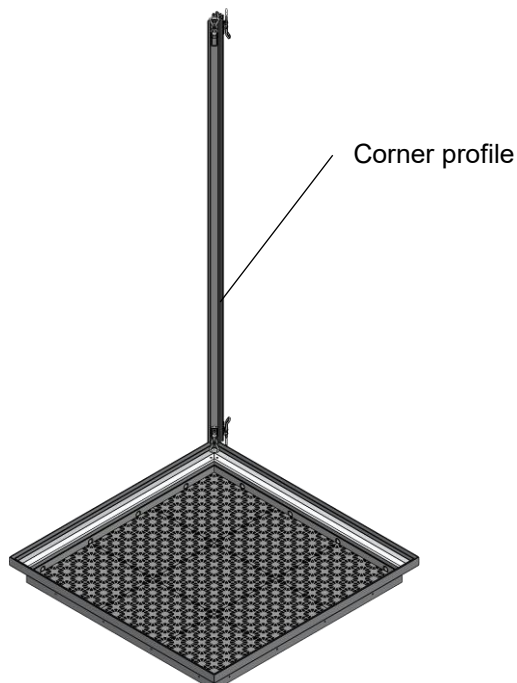

- Insert the wall element into the guides of the corner profile and the floor element.

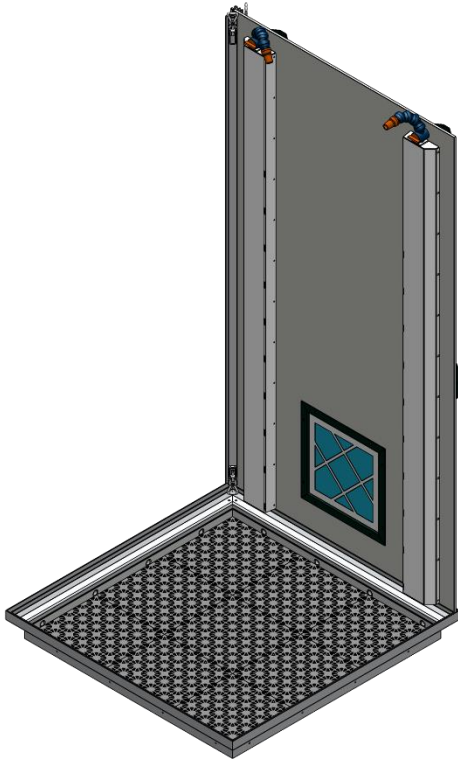

- Insert door element.

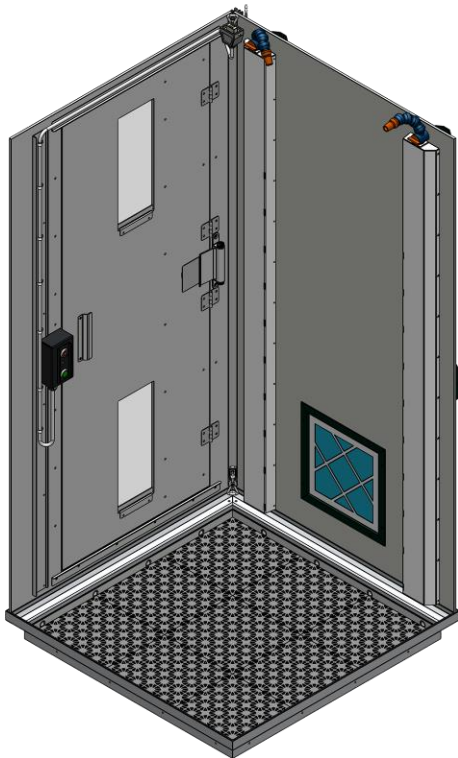

- The following pictures show the further construction.

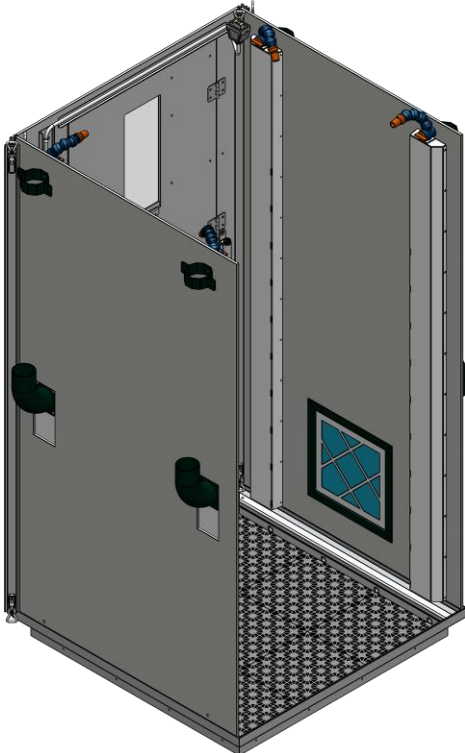

- Position the roof element and brace it in the corners with the quick-release fasteners of the 4 corner profiles.



## 7.2 Air generator

The pictures show the connection of the air generator to the air shower cubicle.

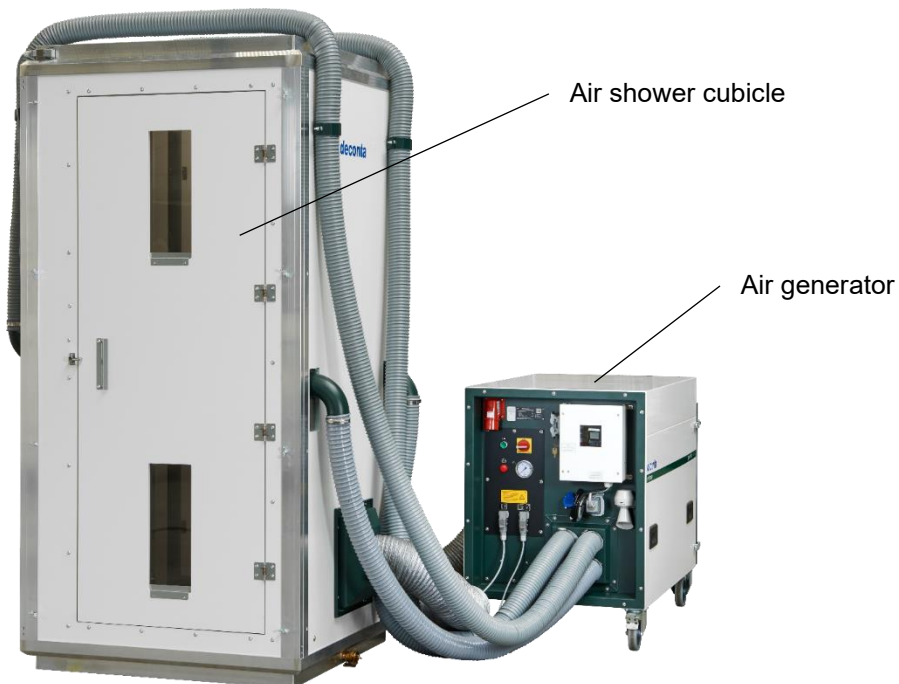

- Connect hose **NW 150** to the air generator and to the air shower cubicle.



- Connect 4x hose NW 75 to the air generator and the air shower enclosure. To lay the hoses over the roof element, they can be fixed to the clamps on the wall element.



### 7.3 Connect control line(s)

The air shower is controlled in 3 variants:

- On / Off control
- Control with automatic shower process
- Forced locking and forced shower control

#### 7.3.1 Version with on/off control

- Connect the cable of the switch box in the cabin to connection "2" on the air generator.



Switch box



Air generator

#### 7.3.2 Version with automatic shower control

- Connect the plugs of the door contacts (both doors) to the roof element.



1. connect the cable on the plug of the roof element above the door clean area to input "1" on the air generator.
2. connect the cable on the plug of the roof element above the contaminated area door to input "2" on the air generator.

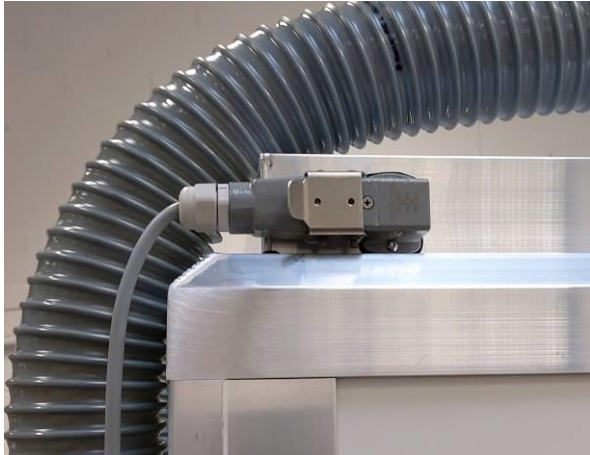

*Roof element air shower enclosure*



*Air generator*

### 7.3.3 Version with forced locking control and forced shower

- Plug the cables of the two door boxes into the plugs of the roof element (Fig. 1).
- Connect the connecting cable of the control unit between the air generator (Fig. 3) and the air shower cubicle (on the roof, Fig. 2).



*Picture 1*



*Picture 2*

Cable connection  
on the air generator



*Picture 3*

## 8 Put into operation

This section contains information for the safe use of the machine.

### 8.1 Qualification of staff

Persons using the machine must fulfil the following requirements:

Person	Required qualification
Operator	Instruction, training by the manufacturer

### 8.2 Warning of residual risks



Contact with wires of a damaged mains connection cable.

Touching machine parts that have become live due to faulty conditions.



Damage due to unsuitable mains voltage.

The appliance can be damaged if it is connected to an unsuitable mains voltage.

Check whether the voltage specified on the rating plate corresponds to the local mains voltage.



The following materials must not be filtered:

- Hot materials (smouldering cigarettes, hot ashes, etc.)
- Flammable, explosive, aggressive materials and dusts

### 8.3 Number of persons

One person is required to use the machine.

### 8.4 Tools required

No tools are required to use the machine.

### 8.5 Equipment required

No equipment is required to use the machine.

### 8.6 Version with on/off control

- Establish 400 V, 16 A power connection.
- Switch on the main switch of the air generator.

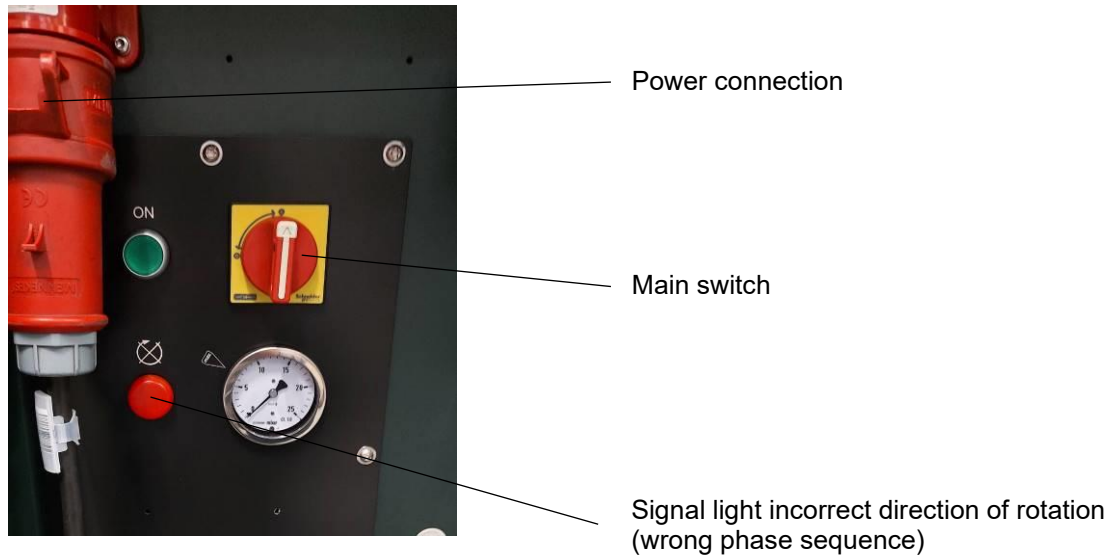

If the phase sequence in the power connection is incorrect, the red lamp lights up and indicates that the fan is rotating in the wrong direction.

The phase sequence must be changed in the surface-mounted device plug.

- After entering the air shower cubicle, the shower process, which is set to run for 90 seconds, can be started by pressing the green button.



### 8.7 Version with automatic shower control

- Establish 400 V, 16 A power connection.
- Switch on the main switch of the air generator.

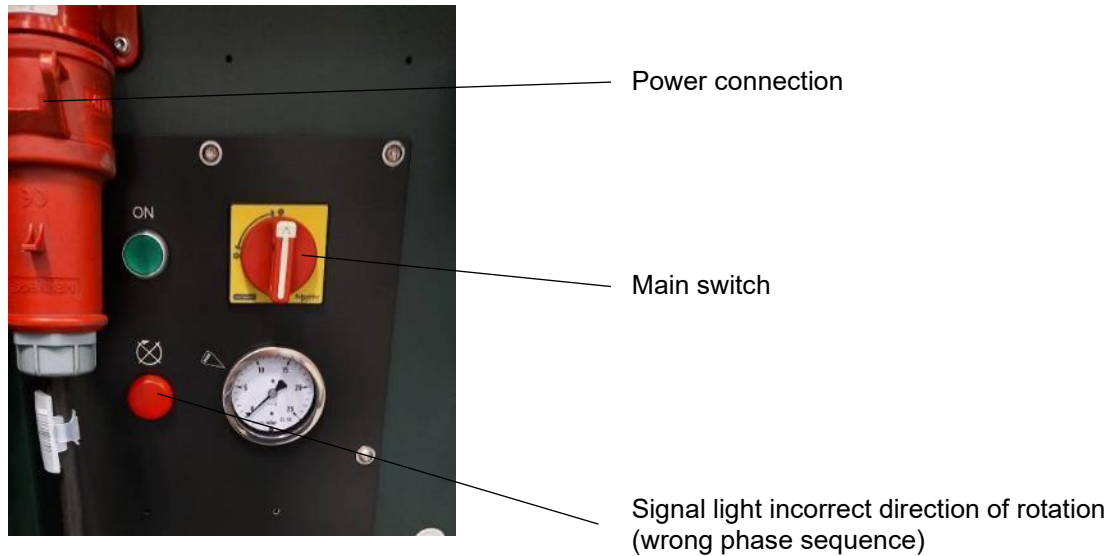

If the phase sequence in the power connection is incorrect, the red lamp lights up and indicates that the fan is rotating in the wrong direction.

The phase sequence must be changed in the surface-mounted device plug.

- The air shower is not activated when entering the work area through the airlock.
- When leaving the work area through the airlock, the air shower starts automatically for a preset time of 90 seconds.

### 8.8 Version with forced locking control and forced shower

- Establish 400 V, 16 A power connection.
- Switch on the main switch of the air generator.



Power connection

Main switch

Signal light incorrect direction of rotation  
(wrong phase sequence)

If the phase sequence in the power connection is incorrect, the red lamp lights up and indicates that the fan is rotating in the wrong direction.

The phase sequence must be changed in the surface-mounted device plug.

- Set the key switch to the "Test" position.



Key switch

- After approx. 5 seconds, switch to the "Automatic" position; the positive locking function is now activated (the green buttons on the door boxes light up).

Entering the work area through the airlock; the forced shower is not activated.

- Press the green button on the door box in white, the door opens
- Entering the air shower cubicle
- Close the door again
- Press the black green button on the door box, the door can be opened
- Leave the air shower cubicle and close the door

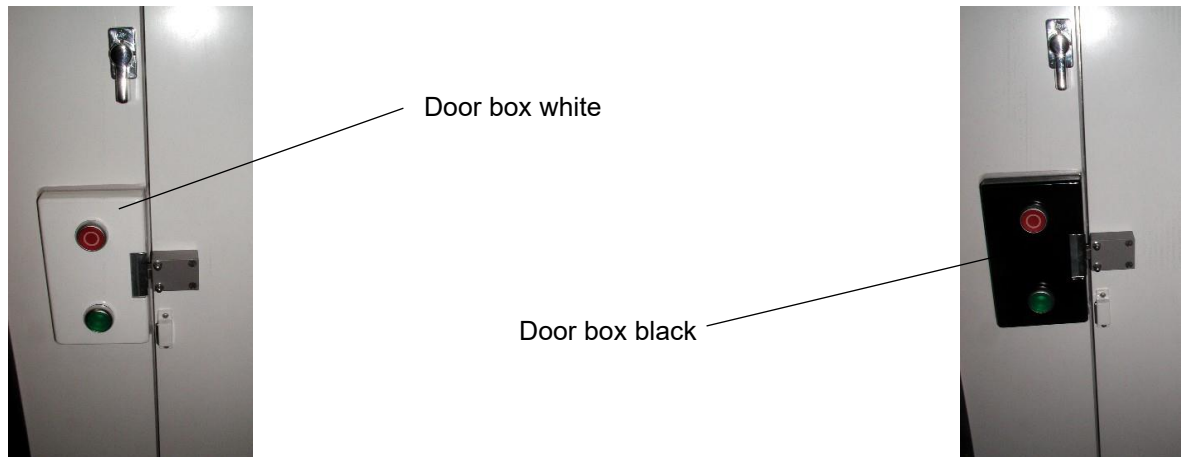

Leaving the work area through the airlock; this activates the forced shower.

- Press the black green button on the door box, the door opens
- Entering the air shower cubicle
- Close the door again
- the air shower is activated for a preset time of 90 seconds
- After the air shower has finished, press the green button on the door box in white, the door can be opened
- Leave the air shower cubicle and close the door

Both the white and black door boxes are fitted with an emergency stop button (red button) to prevent premature exit from the air shower enclosure when the forced locking system is activated. Pressing the red button unlocks the doors and an acoustic alarm sounds.

## 9 Maintenance

This section contains information for the safe maintenance of the machine.

Maintenance comprises all technical and organisational measures during the life cycle of the machine that ensure the safe, economical and functional condition of the machine and prevent environmental damage.

### 9.1 Loss of warranty claims

The manufacturer's warranty is void in the following cases:

- In the event of modifications to the machine that have not been agreed with the manufacturer
- If maintenance is not carried out properly

### 9.2 Maintenance

Maintenance work, including changing/removing filters, may only be carried out by authorised persons wearing suitable protective clothing.

The appliance must be completely disconnected from the power supply for all repair and maintenance work.

**We expressly refer to possible additional regional and national regulations for the maintenance of the appliance technology.**

### 9.3 Warning of residual risks



**Contaminated filters may only be changed in compliance with all relevant safety precautions. Only change filters when the appliance is switched off. Only use approved filters.**



**Do not use any residual fibre binders on the appliance.**



**Pull out the mains plug before opening the housing**

9.3.1 Personal protective equipment required



**Maintenance work, including changing/removing filters, may only be carried out by authorised persons wearing suitable protective clothing.**

**9.4 Information on changing the filter**

The frequency of the filter change depends on the degree of soiling of the filters. As the filter occupancy increases (filter soiling), the air performance decreases.

A pressure gauge is fitted to appliances with SE control to monitor the filter during operation.



We recommend changing the filter at approx. 7 mbar (700 Pascal), marked by the max. arrow on the pressure gauge.

## 9.5 Filter change



Contaminated filters may only be changed in compliance with all relevant safety precautions. Only change filters when the appliance is switched off. Only use approved filters.



Do not use any residual fibre binders on the appliance.



Pull out the mains plug before opening the housing



Maintenance work, including changing/removing filters, may only be carried out by authorised persons wearing suitable protective clothing.

### 9.5.1 Changing the air shower enclosure filter

The filter is located in a filter holder in the lower section of a wall element of the air shower enclosure.

- Carefully pull out the filter and dispose of it
- Insert the new filter



### 9.5.2 Change the air generator filter

- Loosen the clamping fasteners on the intake adapter and remove the intake adapter

**HINWEIS**

**Risk of crushing fingers when fitting / removing the intake adapter**

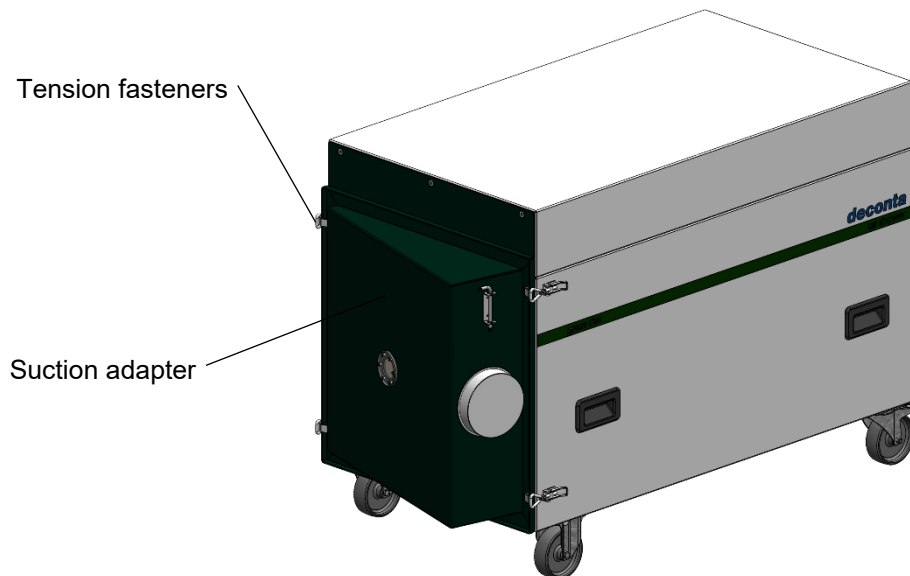

- Carefully remove and dispose of the pre-filter and intermediate filter

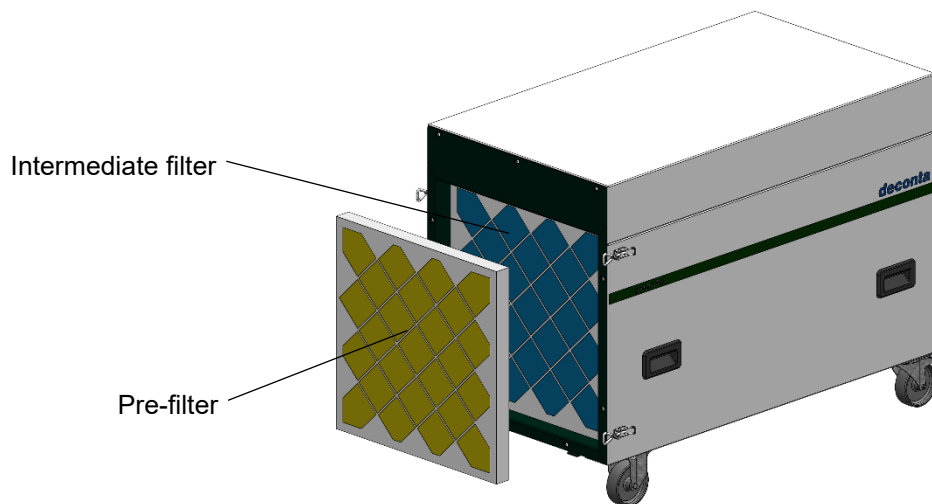

Unscrew the TORX screws using the offset screwdriver supplied

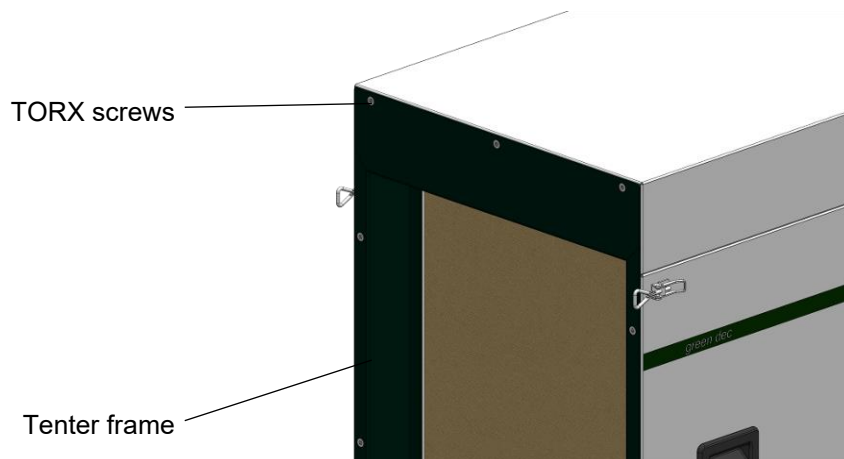

- Remove the clamping frame and remove and dispose of the main filter

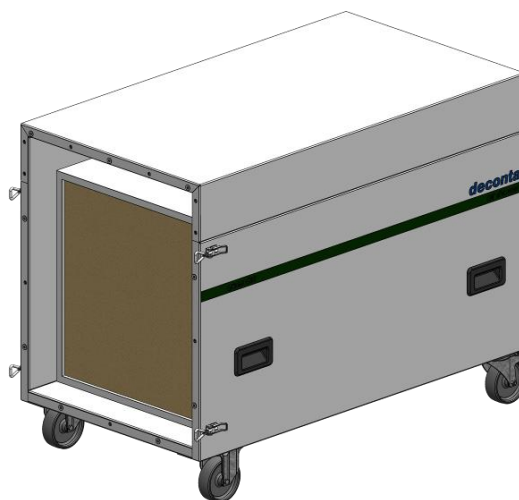

- Check and clean the sealing surfaces on the appliance
- Clean the inside of the housing
- Insert new main filter **in the centre**
- Reattach the clamping frame with screws (tighten the screws evenly)
- Use pre- and intermediate filters
- Refit the suction adapter and clamp it tight with the clamp fasteners

**HINWEIS**

The appliances have only been tested with original deconta HEPA filters. To ensure machine safety, only original deconta filters should be used. If this is not observed, machine safety cannot be guaranteed. This may result in the unintentional and uncontrolled release of hazardous substances into the environment due to filter overload (leakage, filter tear, etc.).

## 9.6 Troubleshooting and fault rectification

This section contains information on safe troubleshooting and fault rectification for the machine.

### 9.6.1 Possible faults and instructions for rectifying faults

The following table provides an overview of faults and troubleshooting measures.

<b>Malfunction</b>	<b>Possible cause</b>	<b>Measure</b>
Power too low	Pre-filter, intermediate filter or main filter soiled	Change the filter as described at 9.5
Device does not work	Power source not in order	Power source inspected and repaired by a qualified electrician
Device does not work	Components on the air generator defective	Have the device repaired by deconta or a workshop authorised by deconta.

## 10 Storage

This section contains information on the safe storage of the machine.

The machine is stored in the following cases:

- After decommissioning for a longer period of non-use
- After decommissioning for a relocation

### 10.1 Ambient conditions

The machine can be stored under the following ambient conditions:

Ambient temperature	0 °C to +45 °C
Relative humidity	70 % non-condensing

### 10.2 Prerequisites

The following requirements must be met for storing the machine:

- Thoroughly cleaned (decontaminated)
- with fitted lids

**We expressly refer to possible additional regional and national regulations for the storage of the appliance technology.**

## **11 Waste disposal**

Disposal is the capture, collection, transformation, selection, processing, regeneration, destruction, utilisation and sale of the materials to be disposed of that are used in the machine.

This section contains information on the proper and correct disposal of the machine.

### **11.1 Qualification of staff**

Persons who dispose of the machine must fulfil the following requirements:

<b>Person</b>	<b>Required qualification</b>
Disposer	Qualified waste disposal company for legally compliant, proper and professional disposal of the machine

### **11.2 Legislation**

The machine is disposed of in accordance with the legal regulations of the country in which the machine is disposed of.

The operator of the machine or the person authorised to dispose of the waste is responsible for compliance with these legal regulations.

### **11.3 Waste**

The waste generated by the machine must be disposed of properly and professionally in accordance with the law.

## 12 EC Declaration of Conformity

The manufacturer / distributor

deconta GmbH  
Im Geer 20  
46419 Isselburg

hereby declares that the following product

Product description: Air shower green dec  
Type designation: 825  
Serial number: see type plate  
Trade name: Air shower green dec  
Year of manufacture: see type plate

Description: Air shower green dec consisting of air generator green dec and variable air shower cabin

complies with all relevant provisions of the applicable legal regulations (hereinafter) - including their amendments valid at the time of the declaration. This declaration of conformity is issued under the sole responsibility of the manufacturer. This declaration relates only to the machine in the state in which it was placed on the market; parts and/or modifications subsequently fitted by the end user are not taken into account.

The following legal provisions were applied:

Machinery Directive 2006/42/EC  
EMC Directive 2014/30/EU  
RoHS Directive 2011/65/EU

The protection targets of the following other legal regulations were met:

Low Voltage Directive 2014/35/EU

The following harmonised standards were applied:

EN 60204-1:2018	Safety of machinery - Electrical equipment of machines - Part 1: General requirements (IEC 60204-1:2016 (Modified))
EN 61000-6-2:2005	Electromagnetic compatibility (EMC) - Part 6-2: Generic standards - Immunity for industrial environments (IEC 61000-6-2:2005)
EN 61439-1:2011	Low-voltage switchgear and controlgear assemblies - Part 1: General requirements (IEC 61439-1:2011)
EN ISO 12100:2010	Safety of machinery - General principles for design - Risk assessment and risk reduction (ISO 12100:2010)
EN ISO 13849-1:2023	Safety of machinery - Safety-related parts of control systems - Part 1: General principles for design (ISO 13849-1:2023)
EN ISO 13849-2:2012	Safety of machinery - Safety-related parts of control systems - Part 2: Validation (ISO 13849-2:2012)
EN ISO 13857:2019	Safety of machinery - Safety distances to prevent hazard zones being reached by upper and lower limbs (ISO 13857:2019)

Name and address of the person authorised to compile the technical documentation:

Boland, Thomas - deconta GmbH - Im Geer 20 - 46419 Isselburg

Place: Isselburg

Date: 17.03.2025

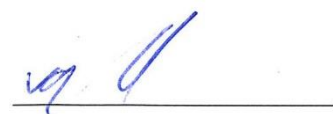

Leiter Konstruktion / head of construction



Leiter Elektro / head of electro